

Chapter 7

ALUMINIUM BONDING AND SPECIAL ASSEMBLIES

1. Screw and bolt fastenings	116
1.1 Conventional screw fastenings	117
1.2 Thread inserts	118
2. Machine rivets	118
2.1 Clinch studs	119
2.2 Blind rivets	119
2.3 Threaded inserts	119
2.4 Repetition fasteners	121
2.5 Self-piercing rivets	121
2.6 Rivet selection criteria	121
2.7 Important note	121
3. Bonding	122
3.1 Advantages of bonding	122
3.2 Designing a bonded joint	122
3.3 Choice of adhesive	123
3.4 Surface preparation	124
3.5 Industrial fabrication	124
3.6 Repair of bonded joints	124
3.7 Durability of bonded joints	124
3.8 Note	125
4. Transition joints	126
4.1 Parts of a transition joint	126
4.2 Properties of transition joints	126
4.3 Conditions of use	126

7. ALUMINIUM BONDING

ARC WELDING is the method of fabrication most commonly used in aluminium sheet metal working in general and in shipbuilding in particular.

However there are other methods of joining which complement arc welding, such as screw and bolt fastenings, riveting and adhesive bonding. Since these methods do not require any application of heat, they have the advantage over welding of not affecting the mechanical properties of the metal or introducing distortion.

They are essential when different materials have to be joined together, e.g. steel to aluminium (or vice versa) or polymers (or their

composites) to aluminium. These 'mixed' joints are found in most of the internal equipment of a ship such as the propulsion system, auxiliaries, pipework, ceilings, door and window frames etc.

Since the early Seventies, the welding of aluminium alloy structures to steel structures has been made easier by the use of aluminium/steel transition joints. One of the most common instances is that of a ship with a superstructure made of aluminium alloy and a steel hull.

This chapter deals with:

- screw and bolt fastenings,
- riveting: machine rivets,
- adhesive bonding,
- transition joint.

1. | SCREW AND BOLT FASTENINGS

Unlike welding, bolting creates a joint that can be 'undone' and is used extensively to make mixed joints, e.g. steel/aluminium. This type of joint is therefore very common in connections between the structure of a ship and much of its equipment, such as engines, auxiliaries, pipework and ventilation ducts.

FELICITA WEST



AND SPECIAL ASSEMBLIES

1.1 | Conventional screw fastenings

The choice of fastening will depend on mechanical considerations following a calculation of the load on the joint. Given the marine environment, increasing use is made of stainless steel fastenings that have the advantage of not rusting and so preserve their original appearance.

When the joint is subjected to extreme variations of temperature, it will be necessary to fit washers to absorb the different rates of expansion between steels and aluminium alloys.

Allowance must also be made for the risk of bimetallic corrosion of the aluminium in contact with the fastenings if they are made from mild, galvanised or stainless steel.

Bearing in mind what is said about galvanic corrosion in Chapter 10, two cases in point must be considered:

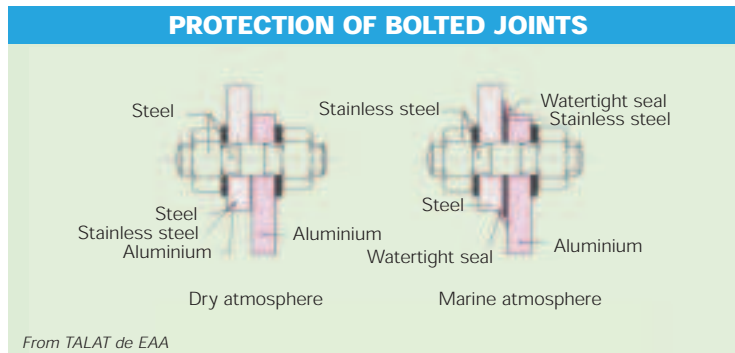

Figure 100

■ the joint is submerged (whether permanently or intermittently) in sea water. Here, we cannot use screw fastenings made from mild or stainless steel without protecting the contacts:

- by placing insulation between the screw and the aluminium structure (figure 100),
- by cathodic protection if they are below the waterline (1).

This risk of galvanic corrosion can also be avoided by using aluminium alloy screws which are anodised to a depth of 15 microns and sealed with bichromate in

7075 T73 or 6108 T8 – their mechanical properties are shown below in table 58, p. 118. Aluminium alloy screws are 50 % lighter than steel screws of equal diameter.

■ the joint is out of water: in zones that are at worst damp as opposed to actually wet, frequent use is made of screw fastenings in stainless steel or galvanised steel.

(1) Cf. Chapter 11.

FELICITA WEST



Despite the difference in potential between steels and aluminium alloys, there is virtually no risk of bimetallic corrosion to aluminium or its alloys aside from a very superficial attack limited to the contact area.

Experience shows that screws made from mild (or stainless) steel that have been screwed into aluminium are often difficult and even impossible to remove when moisture has been allowed to penetrate the thread. This is because of the bimetallic corrosion of the aluminium which, though very superficial, is enough for alumina to form and seize the steel screw.

The simplest way of avoiding this is to apply a viscous grease to the hole and the screw to create a hydrophobic environment that will prevent the ingress of moisture.

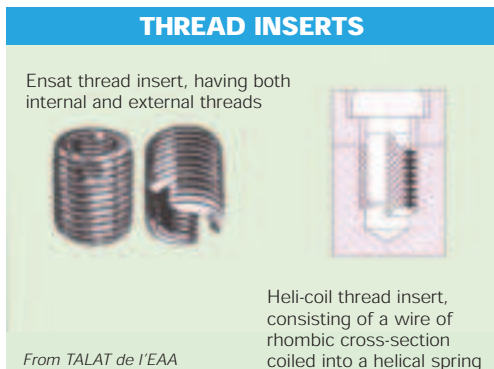

Figure 101

1.2 | Thread inserts

Experience shows that threads in aluminium do not stand up well to frequent dismantling, and here the answer is to fit thread inserts made of steel into the aluminium alloy component (figure 101).

Here again, moisture must not be allowed to penetrate the thread and have the adverse effects described above.

2. | MACHINE RIVETS

Originally developed for aerospace applications, machine riveting is now in widespread use in many sectors of industry, including electronics, domestic appliances and vehicles.

In shipbuilding, this method of joining is used for fixing pipe supports, suspended ceilings, interior trim (salsons, lobbies etc.) and furniture.

Manufacturers of this type of rivet are now offering very reliable systems suitable for use in a wide variety of applications, and machine riveting does not require skilled operatives.

Machine riveting has a number of decisive advantages:

- **Rapid fitting:** Machine riveting can be very fast with the use of pneumatic or hydraulic tools. The actual rate of riveting will of course depend on the nature and configuration of the joints.
- **Ease of control:** Controlling the quality of a joint is made easier by the fact that the clamping force is always guaranteed and optimum because it is less than the force needed to snap the rivet stem.
- **Appearance and impermeability:** With some types of rivet a plastic cap can be clipped over the rivet head to enhance the appearance of the joint. This also helps to

improve the structure's impermeability to air, dust and splash water.

- Mixed joints are possible: aluminium/steel, aluminium/polymer, aluminium/composite etc.

There are two families of machine rivets:

- **clinch studs (or structural rivets)** create the same type of connection as a conventional bolt, although they cannot be undone. Clinch bolts require both sides of the joint to be accessible,

- **blind rivets** are used when only one side of the joint is accessible. They too create a permanent fastening and cannot be undone.

The components are gripped:

- either by clinching a ring onto the stem of the rivet to preload it,
- or by upsetting the body of the rivet by means of the stem head to form a "counter head" on the side opposite the rivet entry.

These operations are carried out with manual riveting tool or with pneumatic or hydraulic rivet guns which are usually sold by the rivet manufacturers.

These fastenings cannot be undone, which ensures the safety of the joint but also complicates repair work. However repairs are rarely needed thanks to the mechanical performance of these rivets. This type of connection is also chosen for its permanence and 'finality'.

MECHANICAL PROPERTIES OF ALUMINIUM ALLOY SCREWS			
Alloy	Rm (MPa)	Rp _{0,2} (MPa)	A %
6108 T6	300	260	8
7075 T73	550	470	10
Steel E24	410	240	24
Stainless steel	660	300	54

Table 58

If a repair is needed, the rivets will have to be removed mechanically, e.g. by extracting the head of clinch studs, pulling out with pliers etc., and then drilling out the fixing holes to a slightly larger diameter.

2.1 | Clinch studs

The components are gripped together by clinching a ring onto the stem of the stud (figure 102).

A clinch stud is fitted in a number of steps:

- the stud is inserted in the fixing hole specially drilled in the components, then the ring is placed on the protruding stem from the opposite end,
- the nose of the tool is positioned up against the ring on the stem of the rivet,
- the pull exerted by the tool squeezes the parts together, clinching the ring on the throat of the stem and leaving a permanent preload,
- the stem above the ring is then snapped off.

Because a high axial pressure is applied to the joint before the ring is clinched, no clearance is left between the joined parts and so excellent impermeability is achieved at the same time.

These rivets have good resistance to shear and vibration.

They are available in steel or aluminium alloy 7075 and 6061. For marine applications, rivets in 7075 must be supplied anodised to at least 15 microns and sealed with a bichromate.

2.2 | Blind rivets

Also known as "breakstem rivets," they are used to make joints where access is only possible on one side. The parts are gripped by compressing the body of the rivet using a stem that snaps off in the head of the rivet and which may or may not remain captive (figure 103). When the stem is captive they are called "structural rivets."

These rivets can withstand significant mechanical stresses and are unaffected by vibration.

These rivets are available in steel or aluminium alloy 7075. For marine applications, rivets in 7075 must be supplied anodised to at least 15 microns and sealed with a bichromate.

2.3 | Threaded inserts

Also called "lost nuts" or "blind nuts," these are threaded nuts mounted "blind" on their support, usually a sheet or shape.

Clinching is achieved by exerting tension on a threaded stem screwed into the threaded insert. This compresses the smooth section to form a 'bulb' that tightly grips the parts together (figure 104). The heads may be flat or countersunk.

These fasteners offer significant potential by acting as lost nuts to make strong and reliable screw connections between relatively thin structures such as partitions.

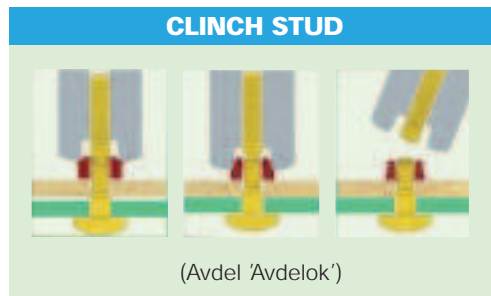

Figure 102



Figure 103

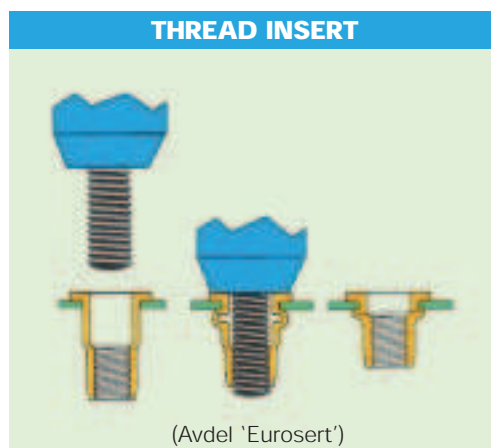

Figure 104

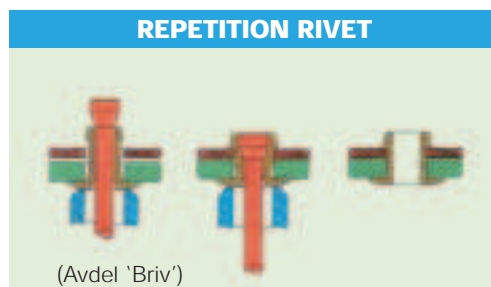
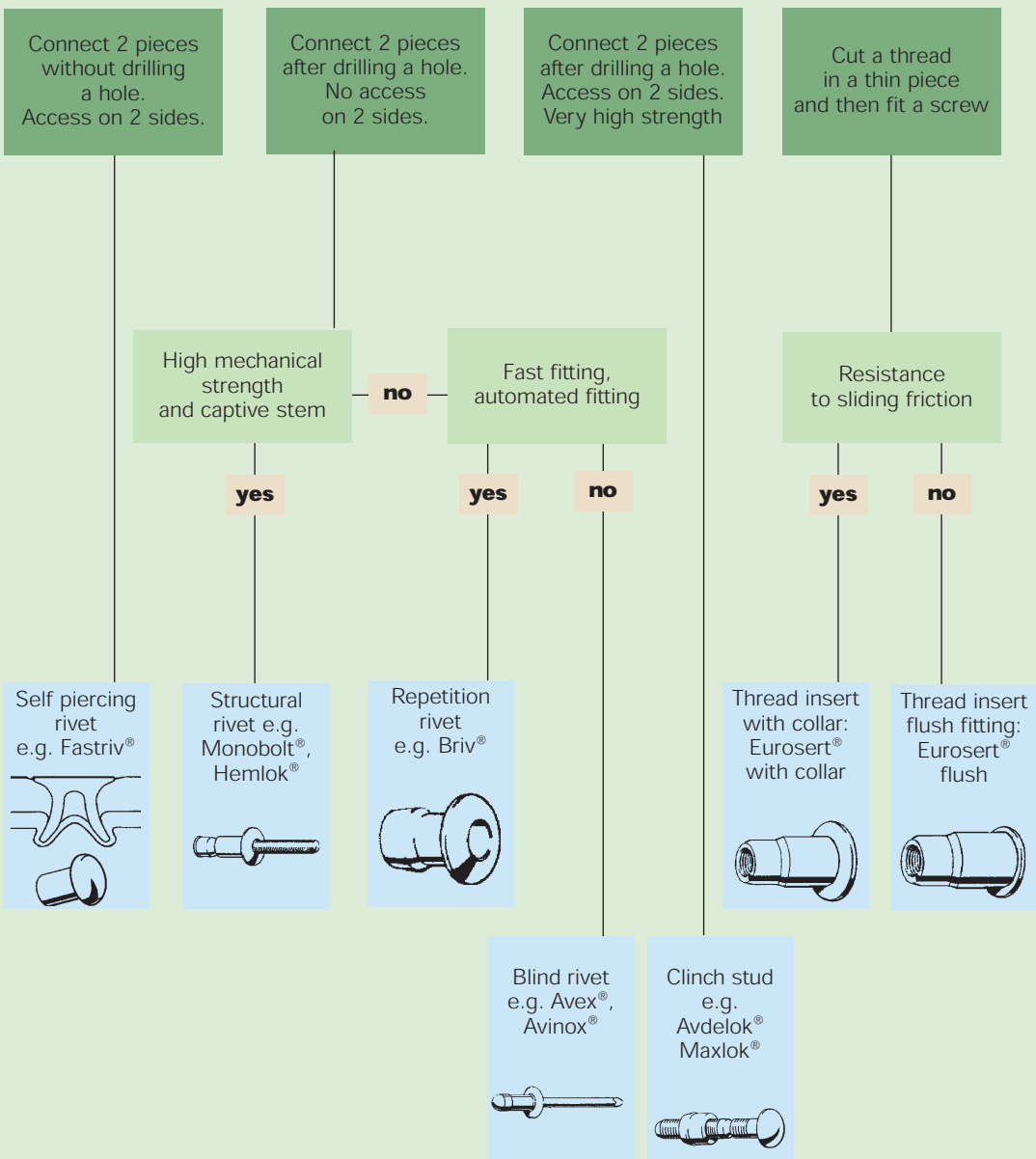

Figure 105

SELECTION GUIDE

YOU WANT TO



From Avdel

2.4 | Repetition fasteners

So called because they are fixed blind (by radial expansion of the stem) with a re-usable punch to which the rivets are fed from a loader (figure 105, p. 119).

These rivets have moderate mechanical strength and are only used for joints under light loads. They can be placed by continuously fed automatic riveters.

2.5 | Self-piercing rivets

This is a hybrid technique that combines riveting and clinching, and requires access on both sides of the joint (figure 106).

It can be automated. The components to be joined together are not pre-drilled, and a tight seal is guaranteed as the rivet does not pierce the final layer of material.

2.6 | Rivet selection criteria

The choice of rivet type depends on a number of criteria (figure 107):

- accessibility on 1 or 2 sides,
- prior drilling,
- intensity of stress on the joint, etc.

2.7 | Important note

When using machine rivets made of mild or stainless steel it is essential to protect the contact zone if this will be permanently or intermittently submerged in (sea) water.

The risk of bimetallic corrosion of the aluminium can be prevented by applying a sealing compound to the contact areas between the plates and to the rivets to prevent ingress of water along the stem.

Sealing compounds must satisfy a number of requirements:

- they must be inert to aluminium alloys,
- the coating must be as thin as possible to minimise the adverse effect of the joint on the strength of the structure,
- they must have good "squeezability" around the stem of the rivet to permit close contact between the plates.

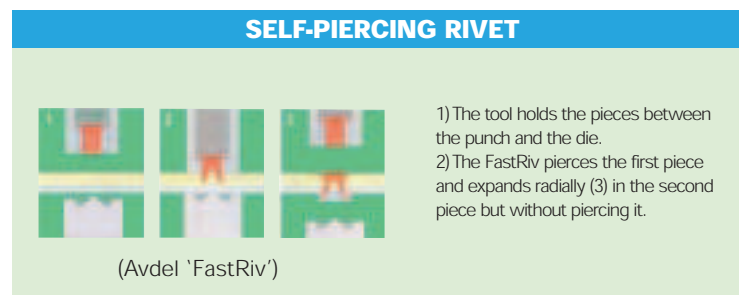

Figure 106



3. | BONDING

Industrial bonding has undergone significant development since 1960, initially in aerospace applications with honeycomb structures. In automotive, the bonding of windscreens to car bodies began in 1963 and has since spread to all types of motor vehicles. Today, all the major industries – automotive, domestic appliances, office equipment, electronics etc. – use adhesive bonding as an assembly method ^[1].

In marine construction, the uses of structural bonding are still limited and concern mainly hybrid joints of aluminium with glass and composites ^[2]. The windows of high speed ships built in Australia for example are bonded, the effect of which is to increase the rigidity of aluminium alloy superstructures ^[3]. The bonding of floors made of aluminium tread plate in the engine room simplifies installation and reduces the transmission of vibrations (Sika brochure photo, page 4-16).

Bonding is used more widely in yacht building, e.g. to attach teak planking to the roof of the deckhouse, whether made of polymer or aluminium, to mount certain items of deck equipment (chain plates, winches, capstans etc.).

Ongoing technological research is aimed at significantly increasing the part played by bonding in shipbuilding, especially in homogeneous aluminium/aluminium joints and mixed aluminium/steel and aluminium/composite joints ^[4].

3.1 | Advantages of bonding

The use of bonding in shipbuilding is set to grow given the advantages it offers, particularly its ability to simplify assembly.

Compared with other joining techniques, bonding can be used to:

- connect materials of different types: aluminium to steel, aluminium to composites etc. Because adhesives also insulate, they prevent the bimetallic corrosion of aluminium in contact with the other materials in the joint,
- compensate differences of expansion in a mixed joint between different materials,
- join age hardening aluminium alloys in the 2000 and 7000 series that cannot be arc welded (2),
- enhance stress distribution (continuous joint),
- absorb vibrations, the more so the thicker the joint,
- ensure built-in impermeability,
- join sub-assemblies that are in an advanced state of completion (painting, various decorations etc.) – this would be impossible with welding as the heat would damage the finishes,
- increase the tolerance of bonded joints compared with other jointing methods.

The use of bonding instead of welding avoids heating and therefore eliminates the heat affected zone, thus bonding preserves the initial mechanical properties of aluminium.

(2) Provided of course they are specially protected for use in marine environments. Stoving the adhesive (for several minutes at temperatures below 200°C) does not affect their mechanical properties.

This has two important implications:

- the thickness of components can be reduced to further save weight in bonded sub-assemblies,
- it eliminates distortion and so saves time.

3.2 | Designing a bonded joint

The success of a bonded joint depends on a number of factors:

- a knowledge of the service conditions of the joints (in particular, specifications must indicate the environment),
- engineers must think 'bonding' from the design stage,
- careful surface preparation,
- correct choice of adhesive – it must suit the service conditions,
- testing to destruction before fabrication to validate the choice of adhesive, and also during fabrication if NDT testing is not possible for reasons of cost, for example,
- fabrication should be closely controlled and automated as far as possible.

There are four types of stress to which a bonded joint can be exposed (figure 108):

- shear,
- tension,
- cleaving and
- peeling.

Bonded joints do not resist well to peeling or cleaving, so should be designed to work in shear and tension.

Joints should be adequately lapped (flat geometry) or sleeved, and the influence of the materials and the thickness of the adhesive layer must also be taken into account.

To compensate for the relatively poor mechanical properties of the bonded joint, the joint's areas should be as large as possible in the usual configurations (figure 109).

The reader will find design rules for bonded joints in the specialist literature [5]. Eurocode 9 deals with bonded joints in Chapter 6-8 "Connections made by adhesive" (3).

(3) Eurocode 9. Design of Aluminium Structures. Part 1 - 1 General rules and rules for buildings.

3.3 | Choice of adhesive

Although adhesives are usually classified by chemical families, their properties – especially chemical – can vary widely from one product to another in the same family.

Cold-curing adhesives are particularly suitable for shipbuilding applications owing to the large areas that have to be bonded.

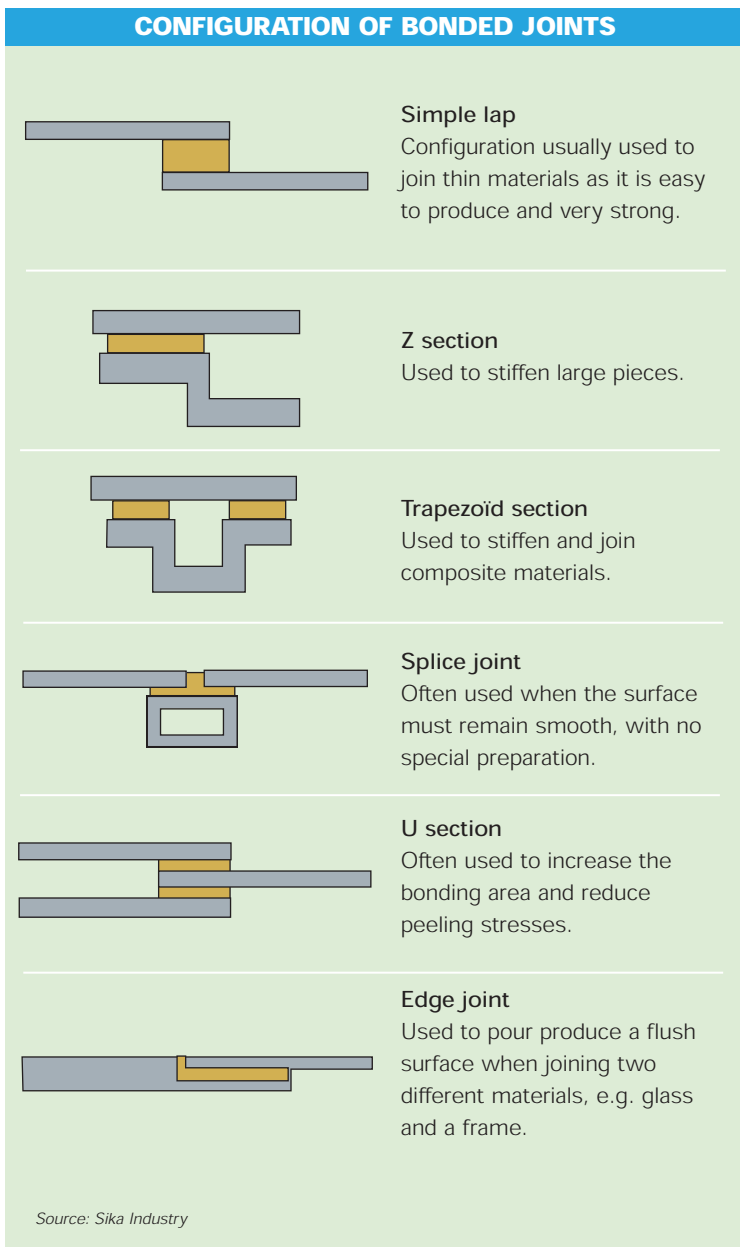

Figure 109

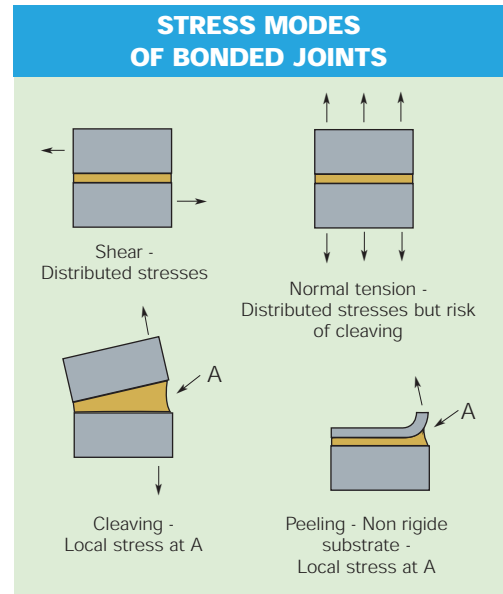

Figure 108

The following adhesives are worth noting in this category:

- one-part polyurethanes are particularly suitable for marine applications (impermeability); some are formulated as semi-structural adhesives. They are used widely for bonding yacht decks. Joints can be several millimetres thick,
- two-part polyurethanes are highly suitable for sandwich panels. They require the use of a primer and set within a few days at ambient temperature. The thickness of the joint sometimes exceeds one millimetre. They are inexpensive.
- two-part epoxies are highly recommended for structural bonds and go off within a few hours at ambient temperature. The ideal bonded joint has a thickness of 0.1 to 0.2 mm,
- modified acrylics go off within a few minutes. Their use is growing rapidly despite their high cost.

Other types of adhesives may also be used, e.g.:

- anaerobic adhesives for thread locking,
- one-part silicone for resolving problems of water tightness,
- one-part epoxies for joints subject to high stress levels and likely to be stoved.

Each of these families includes adhesives specially designed for marine environments.

3.4 | Surface preparation

Good surface preparation is vital to ensure the quality and long life of the bonded joint ^[6].

Two typical procedures for interior bonds are given below:

- First procedure:
 - chemical degreasing, either alkaline or acid (preferred), or using non chlorinated organic solvents like Evopred made by SID (4),
 - chemical conversion – phosphoric or without chromates,
 - apply a primer, e.g. an epoxy.
- Second procedure:
 - degrease (as above),
 - apply a wash primer.

Bonding should be carried out as soon as possible after surface preparation, but the interval can be as long as several days provided the components are stored in a clean, dry room.

There are also pre-coated sheets in which the front face is painted and the back is ready coated with a special epoxy bonding primer. These sheets are ideal for the fabrication of sandwich panels.

3.5 | Industrial fabrication

As far as possible bonding should be done in a well ventilated and dust-free workshop.

It is essential to work carefully and methodically:

- wearing white gloves and safety glasses,
- in strict compliance with the adhesive manufacturer's directions, including storage instructions, e.g. time and temperature.

At each stage of production there must be proper controls of parameters such as resin/hardener ratios, duration and pressure of component fitup during adhesive curing, curing temperature etc.

Standard specimens should be tested to destruction (5) with:

- tension/shear tests with accelerated 'wet pad' ageing,
- or peel tests, to monitor any anomalies.

3.6 | Repair of bonded joints

When structures are required to last for several decades, there comes a time when they may have to be repaired because of damage or for a modification.

Joints made with rigid adhesives applied as a film are very difficult to dismantle. Joints made with flexible adhesives are easy to repair or replace provided they are at least 2 millimetres thick.

Under these conditions the joint can be easily dismantled using a metal wire or vibrating knife and without damaging the substrate.

It is not always necessary to remove the traces of the old adhesive. When treated with a suitable "activator" (which improves the

adhesion of the substrate), they can form an excellent substrate for fresh adhesive of the same type.

3.7 | Durability of bonded joints

The durability of bonded joints depends on factors such as:

- the chemical composition of the adhesives,
- the surface treatment of the aluminium,
- service conditions: stresses, temperature, humidity etc.

The ageing of bonded joints may be accompanied by:

- a loss of mechanical properties,
- creep under stress.

The loss of mechanical properties is due either to the transformation of the surface of the metal (a modification of the oxide layer) or to changes in the properties of the adhesive (softening, hydrolysis etc.).

Water does most damage to bonded joints by attacking the adhesive or causing surface corrosion of the metal (6).

Adhesive bonding has been used in shipbuilding for over 15 years now but our knowledge of the ageing process of bonded joints is still fragmentary.

Over 12 years of experience with marine environments indicates that the two-part epoxies display very good strength provided the joints are well designed and their surfaces are properly prepared.

(4) SID: Société Industrielle de Diffusion F38140 IZEAUX.

(5) According to standard EN 1465 "Adhesives - Determination of tensile lap-shear strength of rigid-to-rigid bonded assemblies".

(6) Which accounts for the importance of surface treating aluminium to reinforce the properties of the natural oxide film.

Table 59 lists some results for creep obtained from standard specimens (according to AFNOR NF T 76-107 except for thickness) made from 5754 and loaded to 25 % of their initial ultimate tensile, exposed to a marine environment.

On alloys belonging to the 5000 and 6000 series, the fatigue strength of joints bonded with one-part epoxy adhesives on samples that have been alkaline degreased and then oiled is better than that of clinched or spot welded joints (figure 110).

Like all polymers, bonded joints are sensitive to the action of ultra violet (UV) rays which affect their mechanical properties. With bonded glazing, the bonded area must be protected by an opaque strip of sufficient size (figure 111).

3.8 | Note

On board ships, bonded joints must comply with fire safety regulations (which in turn depend on the class of ship) [7].

Adhesives are organic compounds so could represent a "fire load" because of their organic nature. The very small amount of adhesive reduces this risk however.

Experience shows that it is possible to meet fire safety regulations with bonding assisted by riveting (or spot welding). Under these conditions, bonded joints retain their mechanical strength during an increase in temperature. At the same time, the integrity of structures must be ensured by adequate insulation that complies with fire safety regulations for ships.

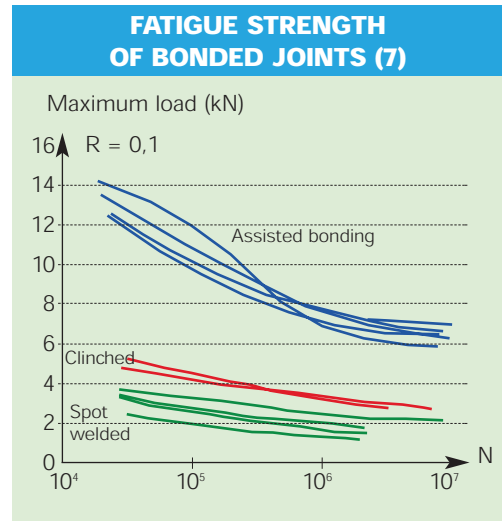

Figure 110

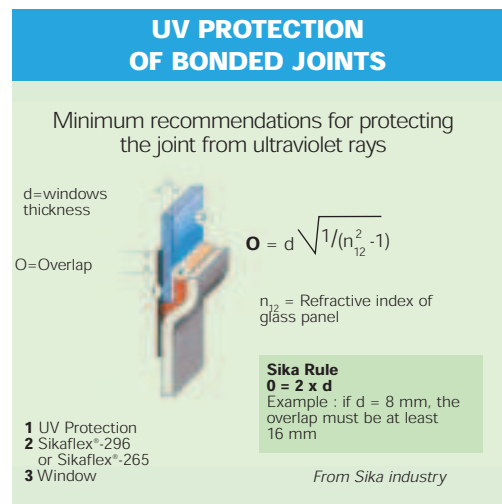

Figure 111

(7) Fatigue tests carried out in 1995 as part of the European Brite 5656 project.

CREEP OF BONDED JOINTS ON 5754			
Adhesive	Surface Preparation	Initial Load (daN)	Life in Marine Environment
One-part epoxy	MEK + Scotch Brite + MEK	147	62 days
	Phosphor anodising	161	3 specimens NR à 12,5 years 2 specimens NR à 8,5 years
Two-part flexible epoxy	Phosphor anodising	258	1 specimen NR à 12,5 years 4 specimens NR à 7 years
One-part flexible epoxy	Phosphor anodising	210	3 specimens NR à 12,5 years 2 specimens NR à 2,5 years
Reinforced acrylic	MEK + Scotch Brite + MEK	230	220 days
	Phosphor anodising	183	1 specimen NR à 12,5 years 3 specimens NR à 2,5 years

MEK: Degreasing with methyl ethyl ketone.
NR: Test specimens not broken after XX days.

Table 59

TRICLAD TRANSITION JOINT

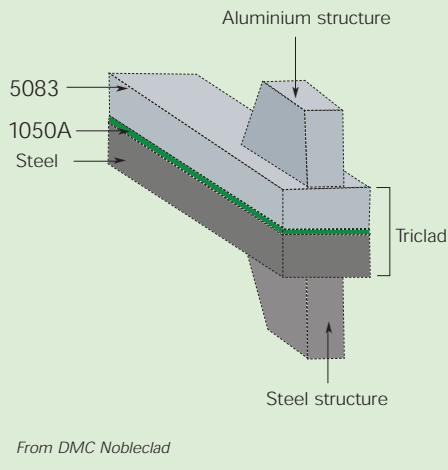

From DMC Nobleclad

Figure 112

BUTT WELD WITH TRICLAD

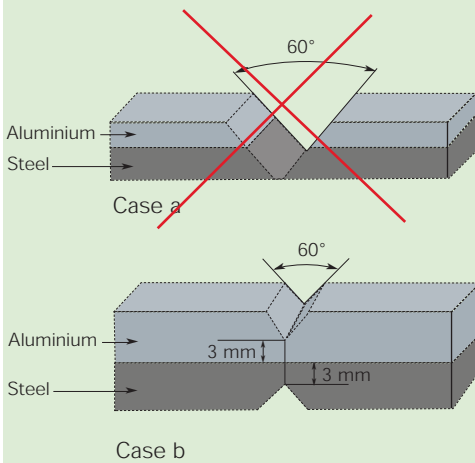

From DMC Nobleclad

Figure 113

SQUARE AND FILLET WELDS WITH TRICLAD

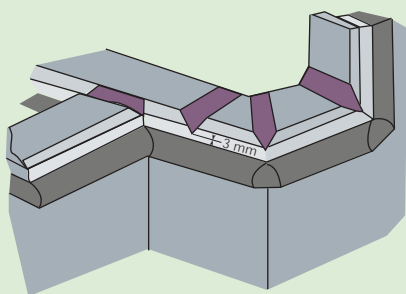

From DMC Nobleclad

Figure 114

4. TRANSITION JOINTS

Introduced at the beginning of the Seventies, the transition joint is a two-metal strip used to arc weld dissimilar metals and alloys, especially when they cannot be joined together by any conventional welding process (8).

A transition joint suitable for connecting aluminium and steel can therefore be used to MIG (or TIG) weld aluminium alloy structures to steel structures on the deck of a ship or offshore platform, for example.

4.1 Parts of a transition joint

The "TRICLAD" transition joint comprises a strip of carbon steel and a strip of aluminium. The strip of aluminium is actually 2 superimposed layers, with a bottom layer of 1050 alloy in contact with the steel and an upper layer in 5083 alloy (figure 112). The three layers (1 steel, 2 aluminium) are joined by the controlled explosion of an explosive charge – explosion cladding.

Unlike the aluminium/steel hybrid joint complexes made by hot corolling, there are no intermetallics in the connection zone between the aluminium and the steel of the TRICLAD.

The explosion is followed by very rapid cooling (lasting approx. 1 microsecond) which prevents the formation of these intermetallics that would otherwise affect the quality of the joint between the aluminium and the steel. It is considered that "micro-fusion" takes place at the interface between the two metals over a thickness of 10 to 50 microns.

4.2 Properties of transition joints

The thickness of the components of standard transition joints, calculated not to exceed 300 °C at the aluminium/steel interface (under normal welding conditions), is given in table 60.

The mechanical properties of TRICLAD are shown in table 61. On test specimens taken square to the plane of the aluminium/steel joint, 'necking' always occurs in the aluminium part beyond the connection zone between the two metals.

4.3 Conditions of use

The width of transition joints must be 4 times the thickness of welded sheets in 5083 alloy. Standard products are 25 mm wide which allows sheet up to 6 mm thick to be welded.

A number of strict rules must be followed when using transition joints to avoid irreparable damage to the connection:

- the temperature at the interface of the joint must be limited to 300 °C in both metals to prevent the formation of intermetallics between the aluminium and the steel. In practice, it is advisable to do a test under normal welding conditions while checking the temperature at the interface using a thermosensitive pencil or a thermocouple,
- make chamfers in each of the metals for butt welds (figure 113a) but *avoid crossing the interface* (figure 113b) as this can damage the joint,

(8) For metallurgical reasons, the fusion of the metals creates intermetallic compounds that weaken the weld seam.

THICKNESS OF TRICLAD TRANSITION JOINTS

Type of Joint	Thickness (mm)					
	5083	1050A	3003	Steel	Titanium	Stainless Steel
5083/1050A/Steel	6	9		25		
3003/Titanium/ Stainless steel			10-12		1,50	20

Table 60

MECHANICAL PROPERTIES OF TRICLAD TRANSITION JOINTS

	5083/1050A/Steel		3003/Titanium/Stain-less Steel	
	Guaranteed (*)	Typical (**)	Guaranteed (*)	Typical (**)
Rm (MPa)	75	120 - 160	100	170 - 190
Shear strength (***)	55	90 - 130		240

(*) According to MIL-J-24445A. (**) Mean figures from DMC Nobelclad. (***) At the steel interface.

Table 61

■ make chamfers in the strip for square joints, as shown in figure 114,

■ never weld on the side face of the transition joint as this can cause irreparable damage.

Bibliography

[1] *Le collage industriel*, MICHEL RACHLINE, Sika Industry, Editions Viloeco, 2001.

[1] "Blending aluminium and composites", DOUG WOODYEAR, *Speed at Sea*, Vol 2, 1996.

[3] "Elastic adhesives used in the construction of high speed ferries", A. VAN GEELEN, Sika Australia Pty Ltd, *13th Fast Ferry International Conference*, February 1997, Singapore.

[4] "Research investigates bonding techniques", PAUL HYNDY, *Speed at Sea*, February 2001, p 47.

[5] "Elastic bonding. The basic principles of adhesive technology and a guide to its cost effective use in industry", Sika Industry, 1998, Verlag Moderne Industrie ISBN 3-478-98203-3.

[6] "Adhesive bonding of aluminium for marine applications", G. E. JUDD, A. MADISSON, *Conference Ausmarine 1996*, p 129-136.

[7] "Structural adhesive bonding of aluminium in marine applications", JAN R. WEITZENÖCK & BRIAN HYMAN, ANDREAS T. ECHTERMEYER, Det Norske Veritas, *The Third International Forum on Aluminium Ships*, Haugesund, Norway, May 1998.

OGIA HIGH-SPEED PASSENGER FERRY





AUSSIE RULES